

LED controller IC
BCR450

Small Signal Discretes



Never stop thinking

Edition 2007-09-26

**Published by Infineon Technologies AG,
81726 München, Germany**

**© Infineon Technologies AG 2007.
All Rights Reserved.**

Attention please!

The information herein is given to describe certain components and shall not be considered as a guarantee of characteristics.

Terms of delivery and rights to technical change reserved.

We hereby disclaim any and all warranties, including but not limited to warranties of non-infringement, regarding circuits, descriptions and charts stated herein.

Information

For further information on technology, delivery terms and conditions and prices please contact your nearest Infineon Technologies Office (www.infineon.com).

Warnings

Due to technical requirements components may contain dangerous substances. For information on the types in question please contact your nearest Infineon Technologies Office.

Infineon Technologies Components may only be used in life-support devices or systems with the express written approval of Infineon Technologies, if a failure of such components can reasonably be expected to cause the failure of that life-support device or system, or to affect the safety or effectiveness of that device or system. Life support devices or systems are intended to be implanted in the human body, or to support and/or maintain and sustain and/or protect human life. If they fail, it is reasonable to assume that the health of the user or other persons may be endangered.

BCR450, LED controller IC

Revision History: 2007-09-26, Rev. 2.1

Previous Version: 2007-03-23, Rev. 1.0

Page	Subjects (major changes since last revision)
All	Editorial changes

1 Bipolar Power LED Controller IC

Features

- Bipolar power technology
- Voltage drop across sense resistor only 0.1...0.2 V
- Maximum operating voltage: 27 V
- Over voltage protection
- Temperature shut down mechanism
- Extremely precise bandgap voltage reference
- Low shut down current < 50 nA in operating voltage range
- Maximum operating output current: 85 mA
- Maximum LED current of 2.5 A possible by using external power transistors
- Digital On/Off switch
- PWM control for LED brightness possible
- Minimum external component required (sense resistor)
- Small package: 2.9 mm x 2.5 mm x 1.1 mm (TSOP6 / SC74)

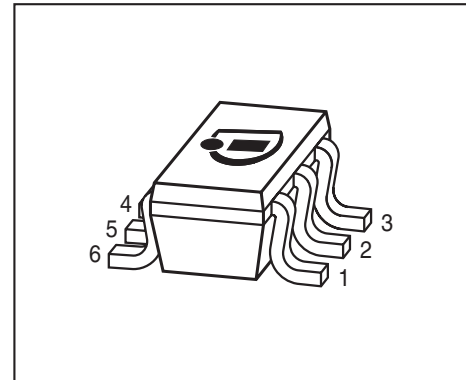

Applications

- LED controller for industrial applications, not qualified for automotive applications
- Universal constant current source
- General illumination e.g. retrofit
- Residential architectural and industrial commercial lighting for in- and outdoor
- Signal and marker lights for orientation or navigation (e.g. steps, exit ways, etc.)

2 Description

The BCR450 is a low cost LED controller IC for industrial applications realized in a bipolar IC technology. The LED Controller is capable to drive high current, high brightness LEDs up to 2.5 A by using additional external output stages as “booster” transistors. For LED currents up to 85 mA the IC can be used as a stand alone device and requires only one voltage sense resistor as an external component

The current supply uses a sense control function with feedback mechanism that regulates the LED current.

The IC can be switched on and off by an external signal, which is also suitable to regulate brightness of the LEDs by PWM dimming. The precise internal bandgap stabilizes the circuit and provides stable current conditions over temperature range.

Furthermore, over voltage protection and temperature shut down mechanism enforce the IC to protect attached LEDs.

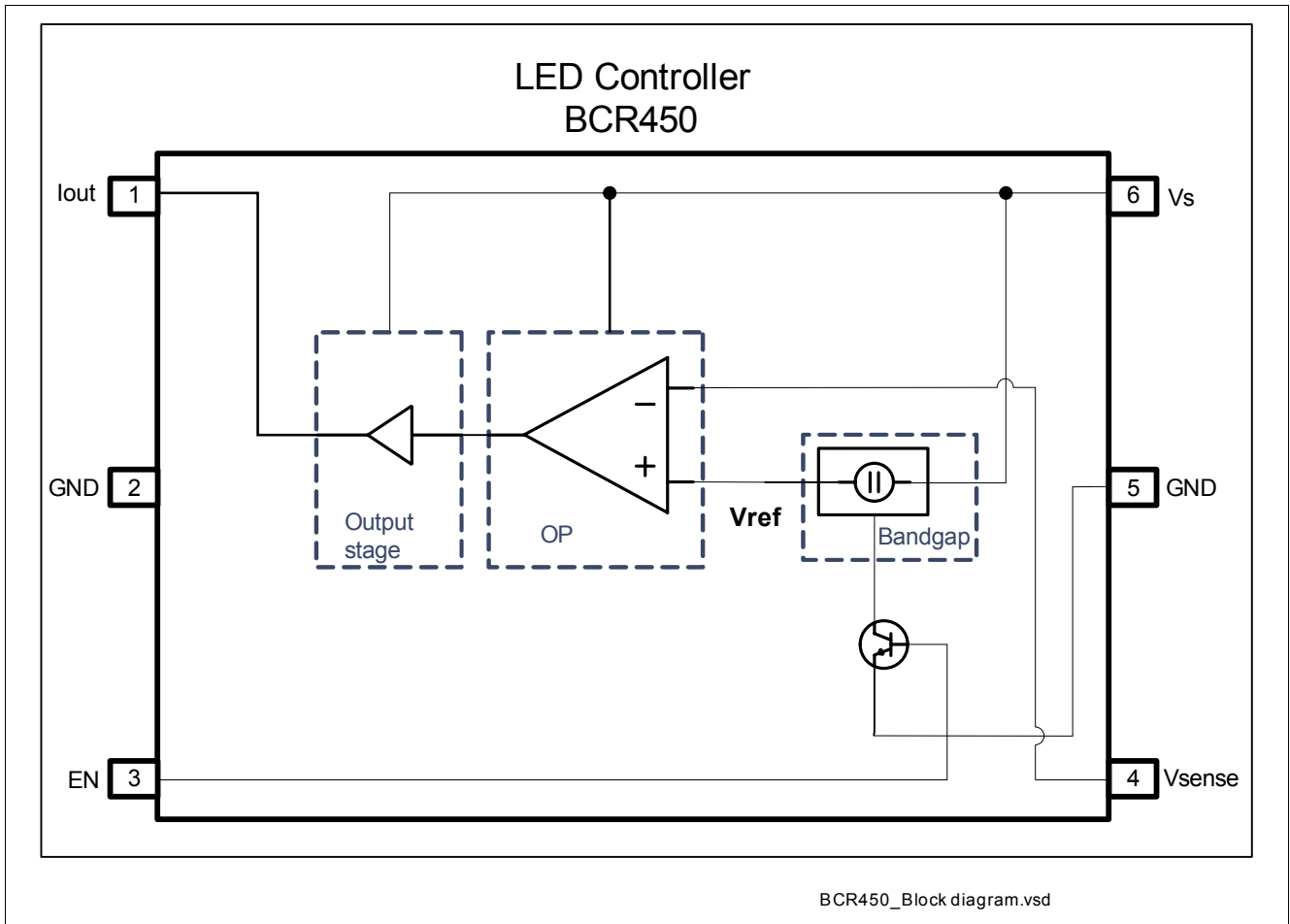
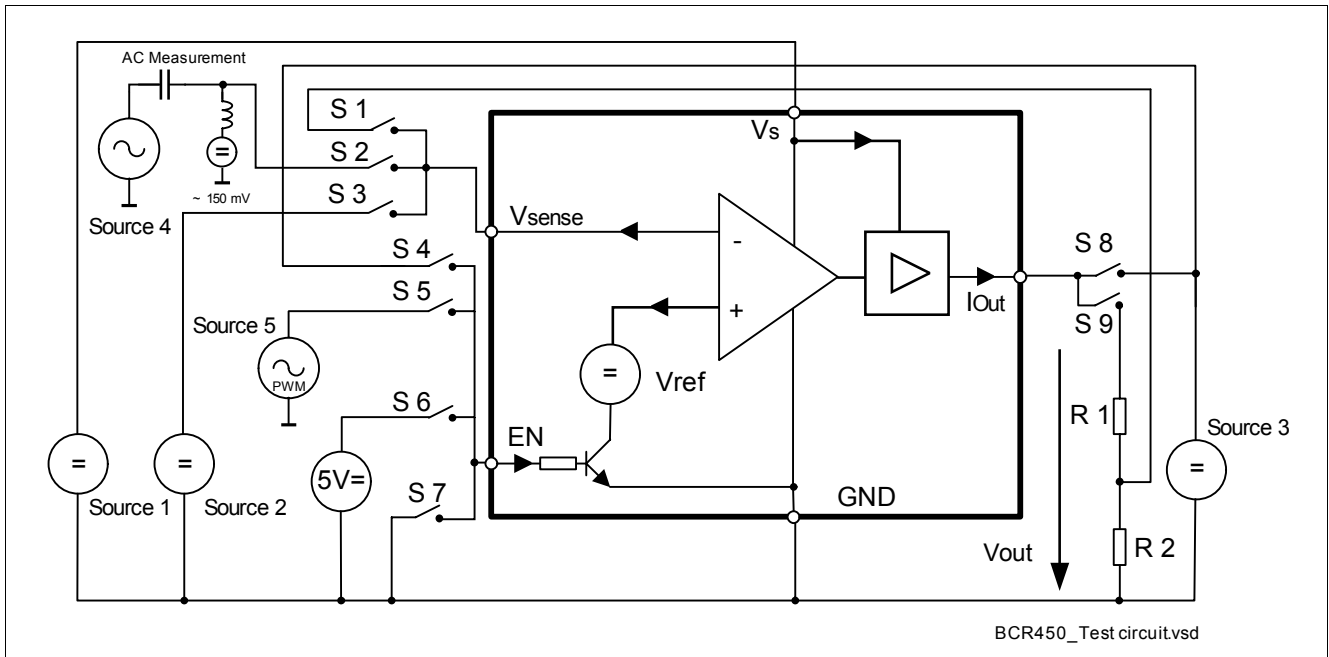

Figure 1 Block diagram

Pin Definition

Table 1 Pin definition and function

Pin number	Pin Symbol	Function
1	I_{out}	Controlled output current to drive LEDs
2	GND	IC ground
3	EN	Power On control voltage pin (<i>PWM input</i>)
4	V_{sense}	Sense control voltage pin for internal feedback mechanism
5	GND	IC ground
6	V_s	Supply voltage

Figure 2 Electrical test circuit

Maximum Ratings
Table 2 Maximum ratings

Parameter	Symbol	Limit Value	Unit
Supply voltage	V_s	40	V
Sense Voltage	V_{sense}	200	mV
Output current	I_{out}	100	mA
Total Power Dissipation; $T_s = 112.5^\circ\text{C}$	P_{tot}	500	mW
Junction temperature	T_J	150	$^\circ\text{C}$
Storage temperature range	T_{STG}	-65... 150	$^\circ\text{C}$
ESD capability Human Body Model ¹⁾	V_{ESD_HBM}	4000	V
ESD capability Machine Model ²⁾	V_{ESD_MM}	400	V

1) For ESD testing, the chip was mounted in a TSOP-6 package on an application board, where GND is electrically connected to the chip GND

2) For ESD testing, the chip was mounted in a TSOP-6 package, where GND is electrically connected to the chip GND

Thermal resistance
Table 3 Thermal resistance

Parameter	Symbol	Value	Unit
Junction - solder point	R_{thJS}	75	K/W

3 Electrical Characteristics

3.1 DC Characteristics

$8\text{ V} < V_s < 27\text{ V}$; $-30\text{ }^\circ\text{C} < T_J < 150\text{ }^\circ\text{C}$, all voltages with respect to ground; current directions as given in [Figure 2](#); unless otherwise specified

All parameters are tested at $25\text{ }^\circ\text{C}$, unless otherwise specified

Table 4 DC Characteristics

Parameter	Symbol	Values			Unit	Note / Test Condition
		Min.	Typ.	Max.		
Overall current consumption	$I_{S_{short}}$	70	90		mA	I_s short; $V_s = 8\text{ V}$ $V_{sense} = 20\text{ mV}$
Overall current consumption	$I_{S_{short}}$	70	90		mA	I_s short; $V_s = 27\text{ V}$ $V_{sense} = 20\text{ mV}$
Overall current consumption	$I_{S_{short}}$			600	μA	I_s short; $V_s = 42\text{ V}$ $V_{sense} = 20\text{ mV}$
Overall current consumption open load	$I_{S_{open\ load}}$	200	250	500	μA	I_s open load; $V_s = 8\text{ V}$ $V_{sense} = 200\text{ mV}$
Overall current consumption open load	$I_{S_{open\ load}}$	250	350	600	μA	I_s open load; $V_s = 27\text{ V}$ $V_{sense} = 200\text{ mV}$
Overall current consumption open load	$I_{S_{open\ load}}$	400	450	1000	μA	I_s open load; $V_s = 42\text{ V}$ $V_{sense} = 200\text{ mV}$
Overall standby current consumption	$I_{S_{standby}}$			200	nA	EN = 0 V; $V_s = 8\text{ V}$ $V_{sense} = 20\text{ mV}$
Overall standby current consumption	$I_{S_{standby}}$			200	nA	EN = 0 V; $V_s = 27\text{ V}$ $V_{sense} = 20\text{ mV}$
Current of enable input	I_{EN}	20	40	70	μA	$V_{sense} = 0\text{-}200\text{ mV}$
Current of driver output	$I_{out\ high}$	70	90		mA	$V_{sense} = 20\text{ mV}$; $V_s = 8\text{ V}$
Current of driver output	$I_{out\ low}$			100	nA	$V_{sense} = 200\text{ mV}$; $V_s = 8\text{ V}$
Current of Sense input	I_{sense}			200	nA	$V_{sense} = 20\text{ mV}$
Current of Sense input	I_{sense}			100	nA	$V_{sense} = 200\text{ mV}$
Voltage of Driver output	V_{out}		6		V	$I_{out} = 15\text{ mA}$; S1, S6, S8, S9 = on; R1 = 390 Ω ; R2 = 10 Ω ; see Figure 2
Voltage of Sense input	V_{sense}	135	150	165	mV	$I_{out} = 15\text{ mA}$; $V_s = 8\text{ V}$ S3, S6, S8 = on; R1 = 390 Ω ; R2 = 10 Ω see Figure 2

Table 4 DC Characteristics (cont'd)

Parameter	Symbol	Values			Unit	Note / Test Condition
		Min.	Typ.	Max.		
Voltage of Sense input	V_{sense}	135	150	165	mV	$I_{out} = 15\text{mA}$; $V_s = 27\text{V}$ S3, S6, S8 = on; R1 = 390 Ω ; R2 = 10 Ω see Figure 2
Over voltage Protection	$V_{s,OV}$	27			V	$I_{out} \rightarrow 0\text{ A}$
Off- load output current	I_{CC2}	70			mA	$V_{sense} = 0\text{ V}$
Delta sense voltage	ΔV_{sense}	2	10	50	mV	$I_{out}: 0 \rightarrow 50\text{ mA}$
Lowest sufficient battery voltage overhead	$V_s - V_{out}$		1.2		V	$I_{out} < 50\text{ mA}$
Temperature shut down	Th_{TSD}	150	170	190	$^{\circ}\text{C}$	$I_{out} \rightarrow 0\text{ A}$; refer to T_A

3.2 AC Characteristics

$8\text{ V} < V_s < 27\text{ V}$; $-30\text{ }^{\circ}\text{C} < T_j < 150\text{ }^{\circ}\text{C}$, all voltages with respect to ground; current directions as given in [Figure 2](#); unless otherwise specified

All parameters are tested at $25\text{ }^{\circ}\text{C}$, unless otherwise specified

Table 5 AC Characteristics ¹⁾

Parameter	Symbol	Values			Unit	Note / Test Condition
		Min.	Typ.	Max.		
Open Loop Gain	A_{VD}		65		dB	$V_s = 8\text{ V}$
	A_{VD}		70		dB	$V_s = 27\text{ V}$
Unity Gain Bandwidth	G_{BW}		600		kHz	$V_s = 8\text{ V}$
	G_{BW}		1000		kHz	$V_s = 27\text{ V}$
Phase Margin ²⁾	PM_G		109		$^{\circ}$	$V_s = 8\text{ V}$
	PM_G		102		$^{\circ}$	$V_s = 27\text{ V}$

1) $V_{out} = 6\text{ V}$; S2, S6, S8, S9 = on; R1 = 390 Ω ; R2 = 10 Ω , see [Figure 3](#)

2) Refer to Loop Gain

3.3 Digital Signals

All parameters are tested at 25 °C, unless otherwise specified

Table 6 Digital Control Parameter (EN)

Parameter	Symbol	Values			Unit	Note / Test Condition
		Min.	Typ.	Max.		
Power on control voltage range	U_{Pon}	-0.3		5	V	
Control voltage for power on	U_{On}	0.6	0.85	5	V	
Control voltage for power off	U_{Off}	-0.3		0.35	V	
PWM signal frequency	f_{PWM}			1000	Hz	$t_{duty\ cycle} = 1\%$; signal level reaches 100% in on and off mode
PWM Duty cycle	$t_{duty\ PWM}$	5			%	$f = 5\text{ KHz}$; signal level reaches 100% in on and off mode
PWM voltage	U_{PWM}			5	V	

3.4 Transient Parameters

$8\text{ V} < V_S < 27\text{ V}$; $-30\text{ °C} < T_J < 150\text{ °C}$, all voltages with respect to ground; current directions as given in [Figure 2](#); unless otherwise specified

All parameters are tested at 25 °C, unless otherwise specified

Table 7 Digital Control Parameter (EN)

Parameter	Symbol	Values			Unit	Note / Test Condition
		Min.	Typ.	Max.		
Response Time	T_{ON}			10	μs	EN: 0 -> 5 V @ $t_{rise} < 20\text{ ns}$ $t_{risetime} @ (10\% \dots 90\%) * V_{sense}$ ($I_{out} \sim 15\text{ mA}$); $R_{sense} = 10\ \Omega$ see Figure 4
	T_{OFF}			70	μs	EN: 5 V -> 0 @ $t_{fall} < 20\text{ ns}$ $t_{falltime} @ (90\% \dots 10\%) * V_{sense}$ ($I_{out} \sim 15\text{ mA}$); $R_{sense} = 10\ \Omega$ see Figure 4

3.5 AC Test Circuits

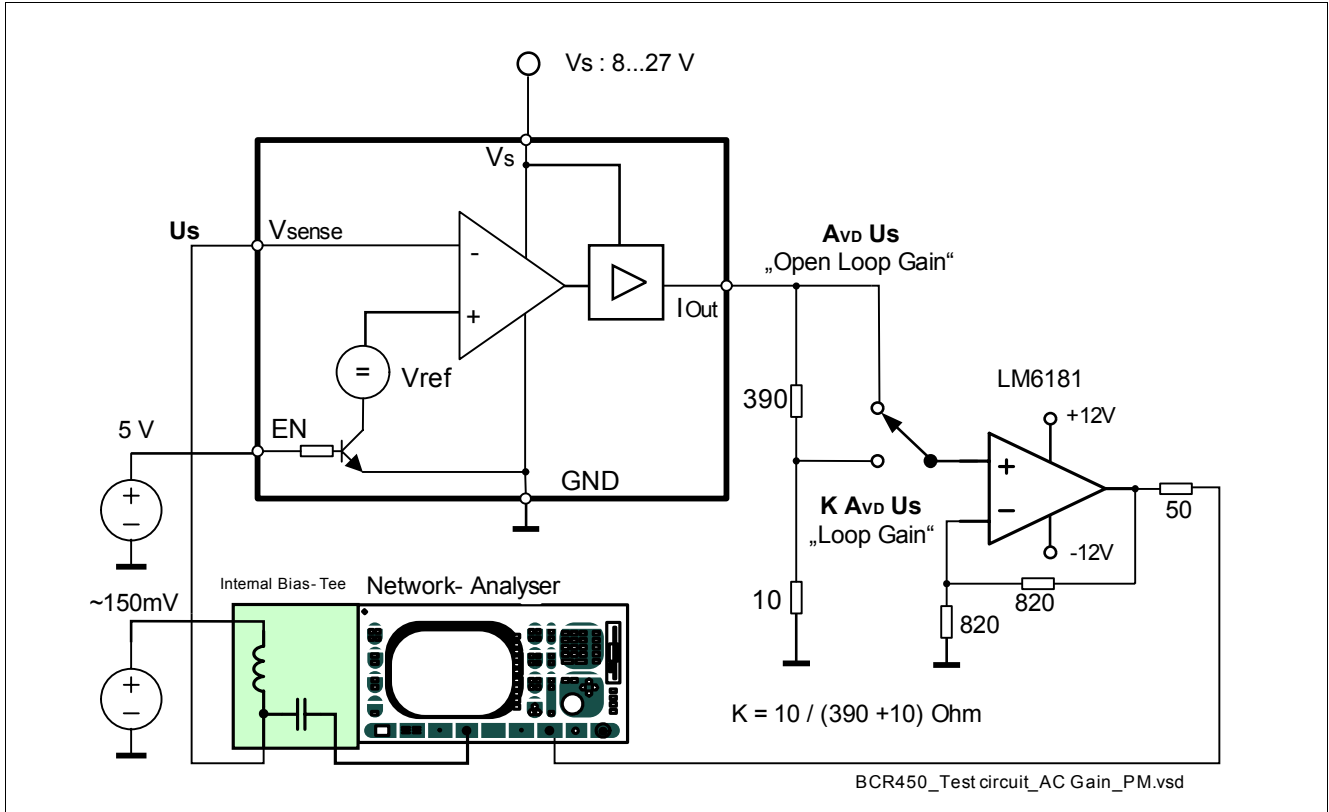

Figure 3 Electrical test circuit for open loop gain, loop gain and phase margin

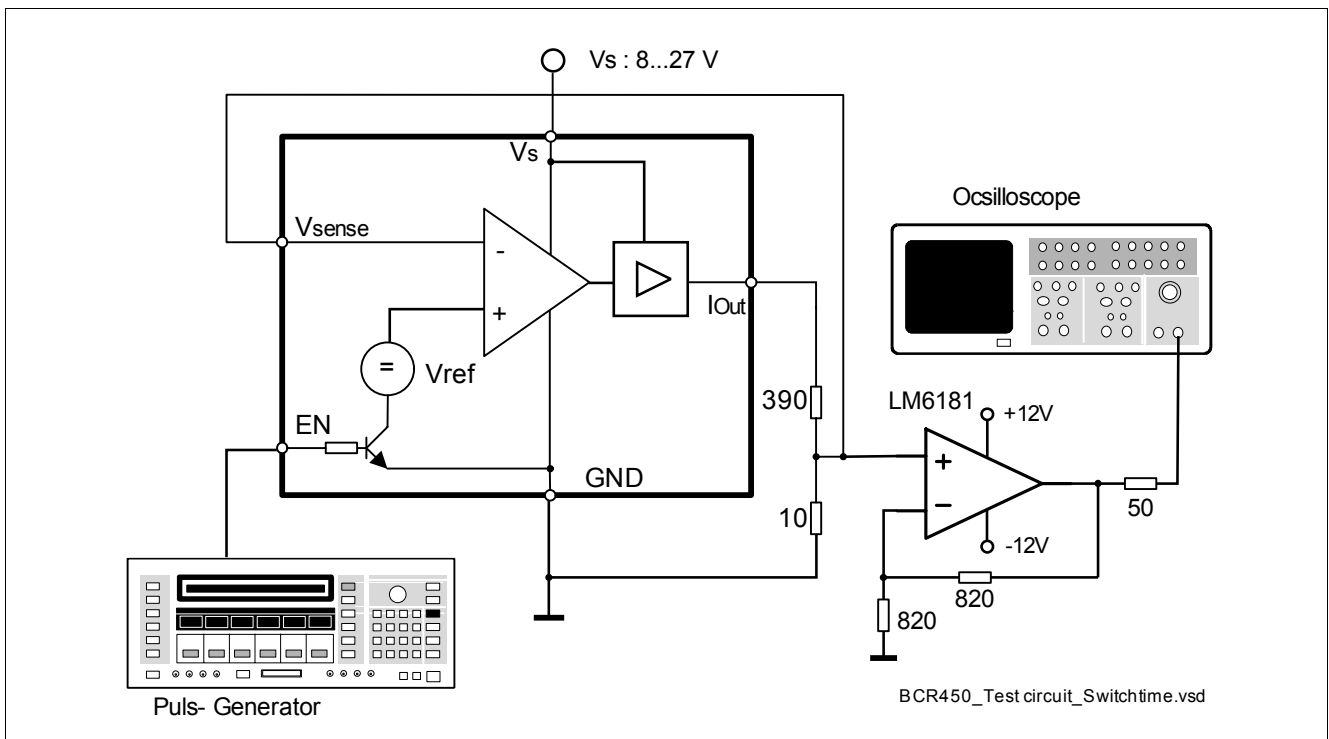

Figure 4 Electrical test circuit for response time

4 Measured Parameters

BCR450 IC has been measured in test bench with undefined high thermal resistance
This is valid for all diagramed DC- and AC- Parameters

4.1 DC- Parameter

$$V_{out} = 1.0 \text{ V, EN} = 2.4 \text{ V}$$

I_S vers Temperature (V_S); $V_{sense} = 20 \text{ mV}$

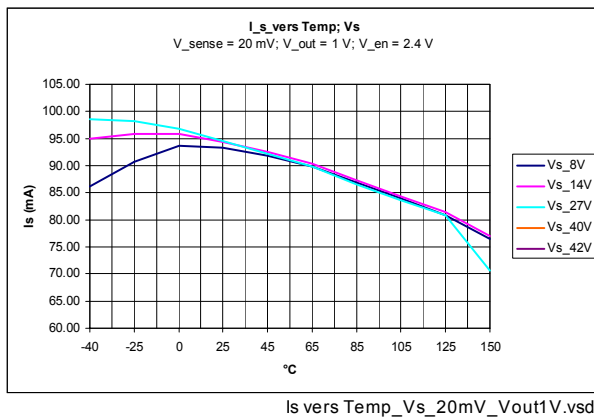

I_S vers V_S (Temperature); $V_{sense} = 20 \text{ mV}$

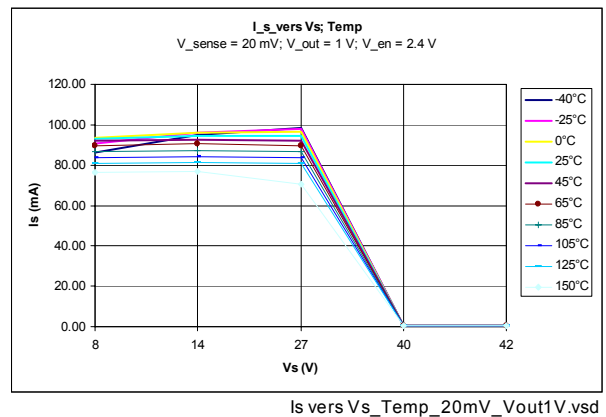

I_S vers Temperature (V_S); $V_{sense} = 200 \text{ mV}$

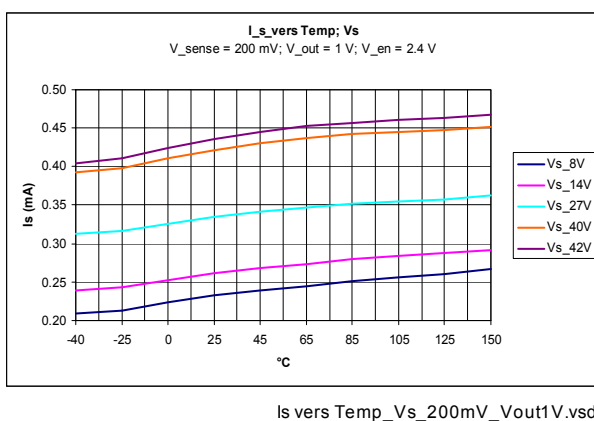

I_S vers V_S (Temperature); $V_{sense} = 200 \text{ mV}$

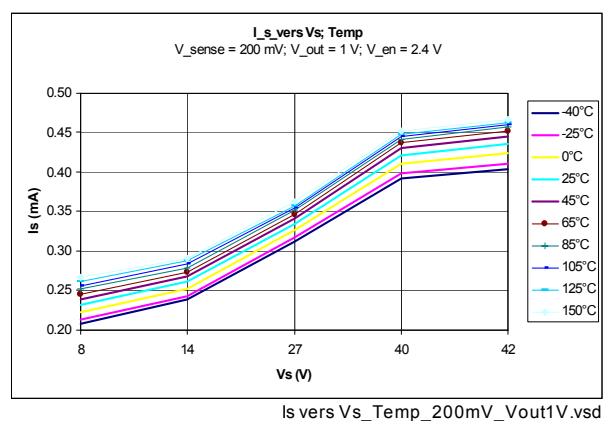

Measured Parameters

I_{en} vers Temperature (V_s); $V_{sense} = 20\text{ mV}$

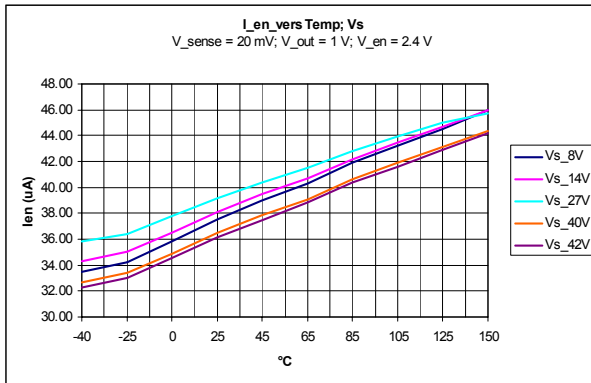

len vers Temp_Vs_20mV_Vout1V.vsd

I_{en} vers V_s (Temperature); $V_{sense} = 20\text{ mV}$

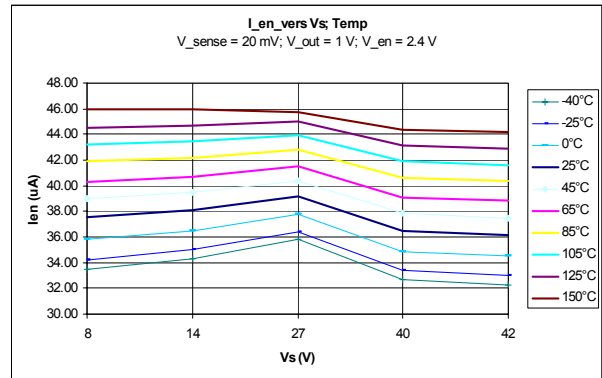

len vers Vs_Temp_20mV_Vout1V.vsd

I_{en} vers Temperature (V_s); $V_{sense} = 200\text{ mV}$

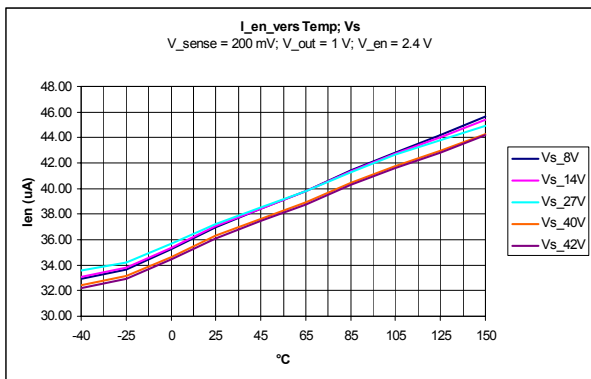

len vers Temp_Vs_200mV_Vout1V.vsd

I_{en} vers V_s (Temperature); $V_{sense} = 200\text{ mV}$

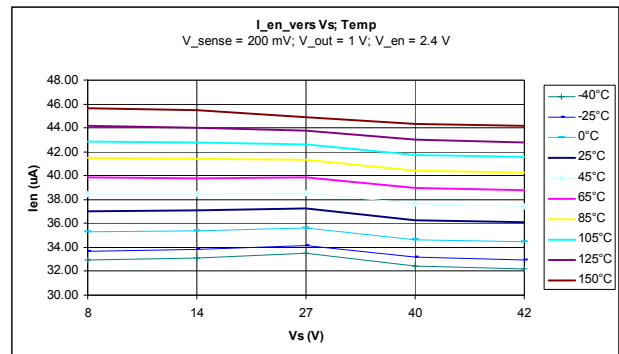

len vers Vs_Temp_200mV_Vout1V.vsd

I_{sense} vers Temperature (V_s); $V_{sense} = 20\text{ mV}$

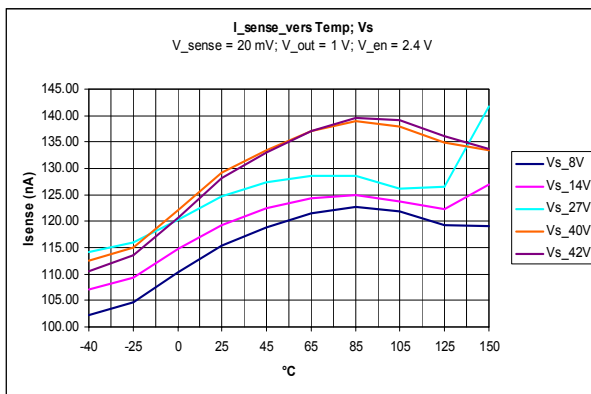

lsense vers Temp_Vs_20mV_Vout1V.vsd

I_{sense} vers V_s (Temperature); $V_{sense} = 20\text{ mV}$

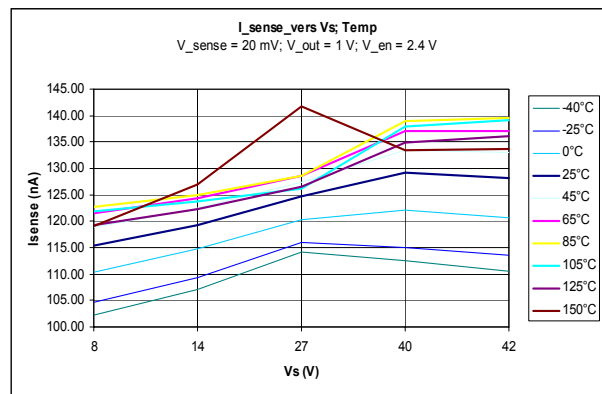

lsense vers Vs_Temp_20mV_Vout1V.vsd

Measured Parameters

I_{sense} vers Temperature (V_s); $V_{sense} = 200$ mV

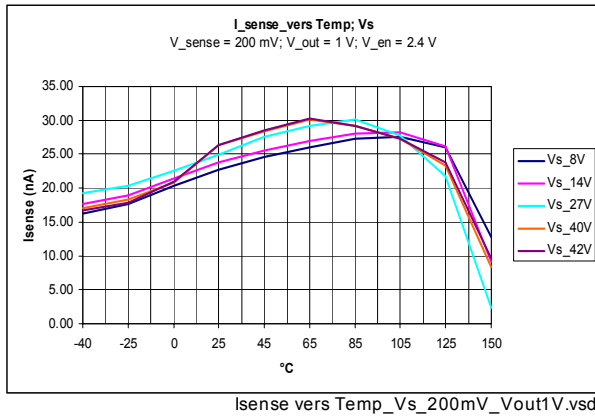

I_{sense} vers V_s (Temperature); $V_{sense} = 200$ mV

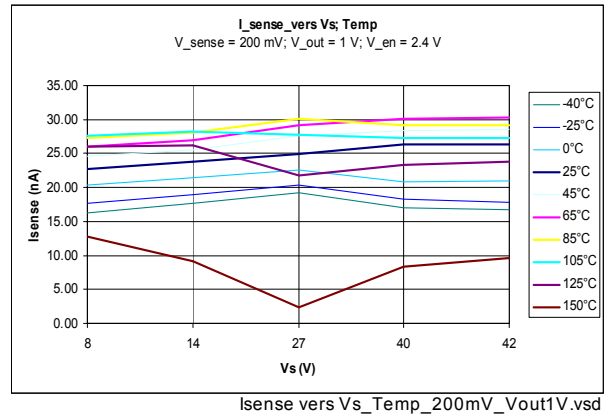

I_{out} vers Temperature (V_s); $V_{sense} = 20$ mV

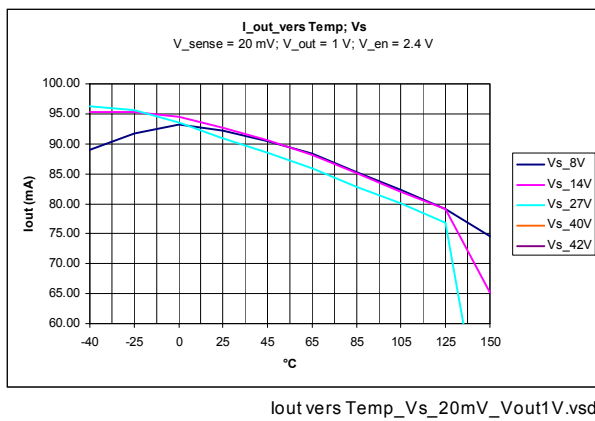

I_{out} vers V_s (Temperature); $V_{sense} = 20$ mV

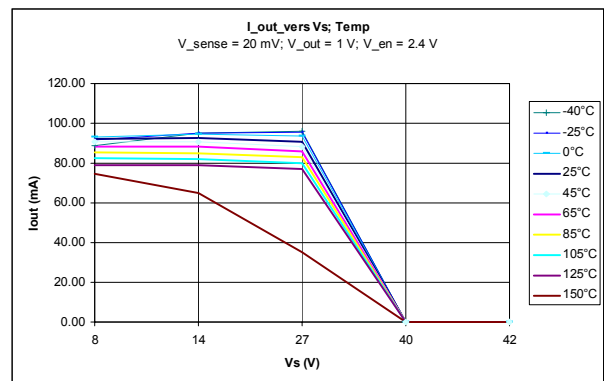

I_{out} vers Temperature (V_s); $V_{sense} = 200$ mV

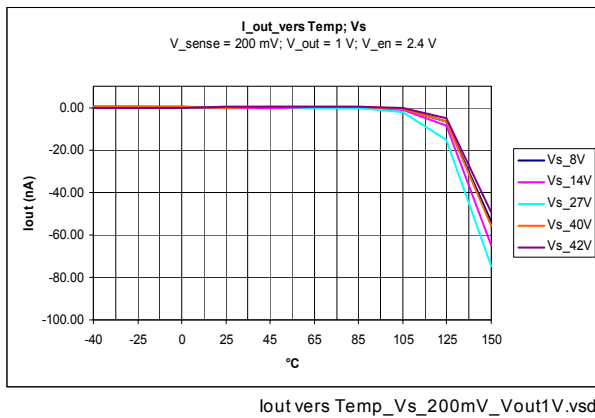

I_{out} vers V_s (Temperature); $V_{sense} = 200$ mV

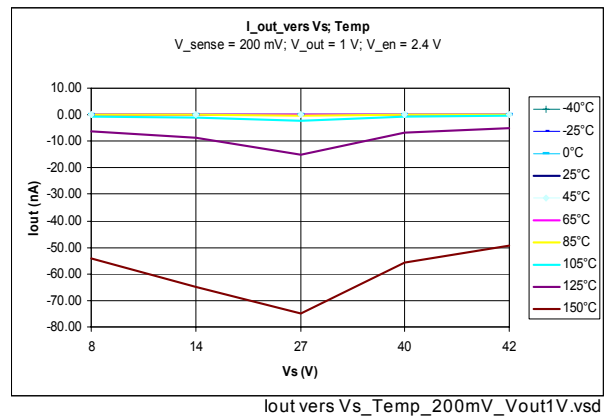

$V_{out} = \text{open}$, $V_{sense} = 200 \text{ mV}$; $EN = 2.4 \text{ V}$

I_s vers Temperature (V_S)

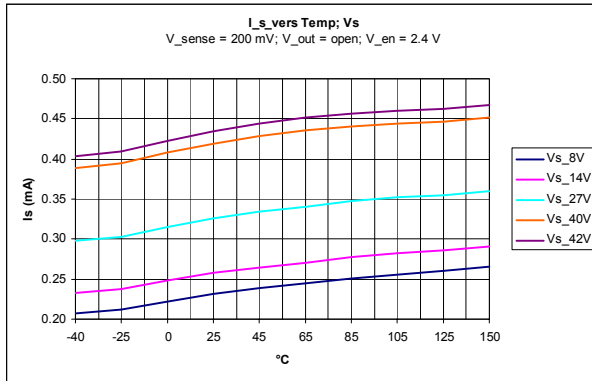

Is vers Temp_Vs_200mV_Voutopen.vsd

I_s vers V_S (Temperature)

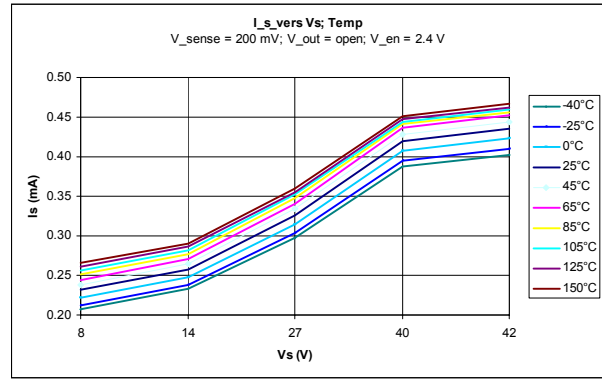

Is vers Vs_Temp_200mV_Voutopen.vsd

I_{en} vers Temperature (V_S)

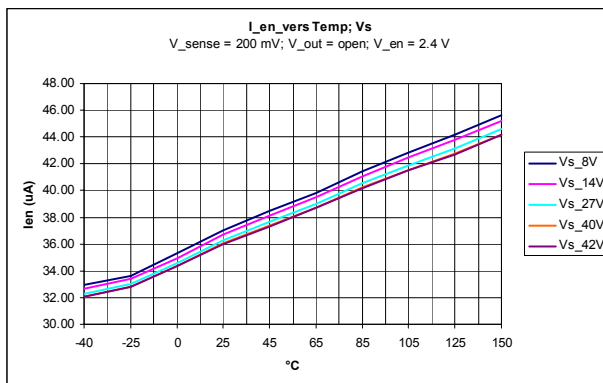

Ien vers Temp_Vs_200mV_Voutopen.vsd

I_{en} vers V_S (Temperature)

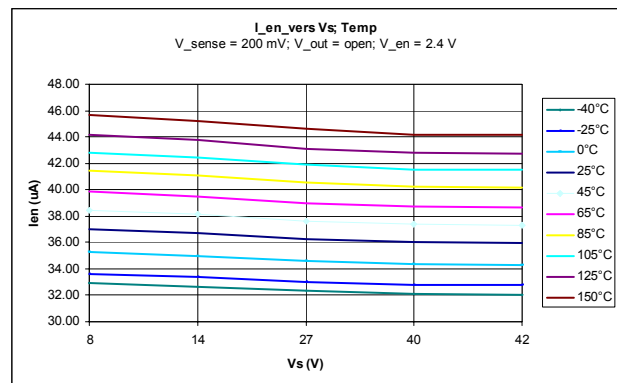

Ien vers Vs_Temp_200mV_Voutopen.vsd

I_{sense} vers Temperature (V_S)

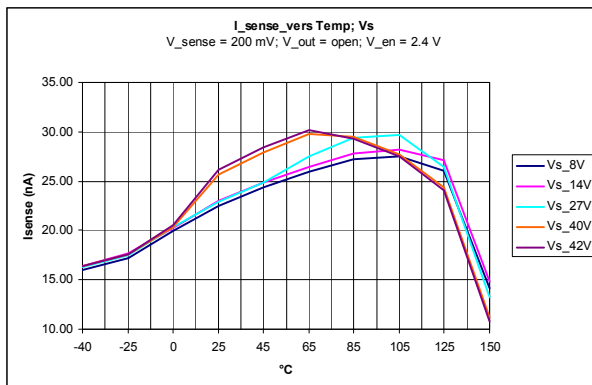

Isense vers Temp_Vs_200mV_Voutopen.vsd

I_{sense} vers V_S (Temperature)

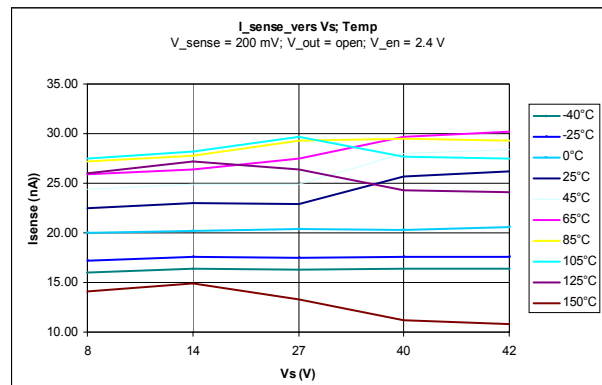

Isense vers Vs_Temp_200mV_Voutopen.vsd

Measured Parameters

$V_s = 8\text{ V}$, $V_{out} = 1\text{ V}$; $EN = 2.4\text{ V}$

I_{out} vers Temperature (V_{sense})

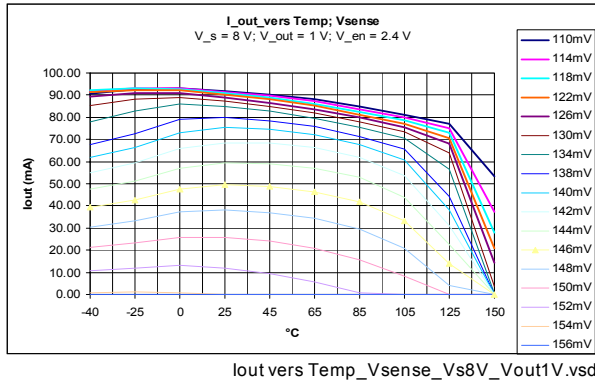

I_{out} vers V_{sense} (Temperature)

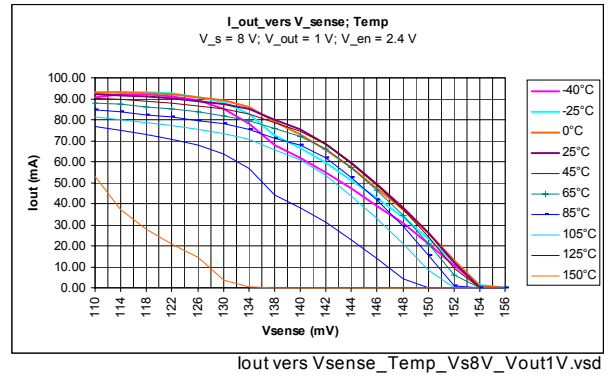

$V_s = 14\text{ V}$, $V_{out} = 1\text{ V}$; $EN = 2.4\text{ V}$

I_{out} vers Temperature (V_{sense})

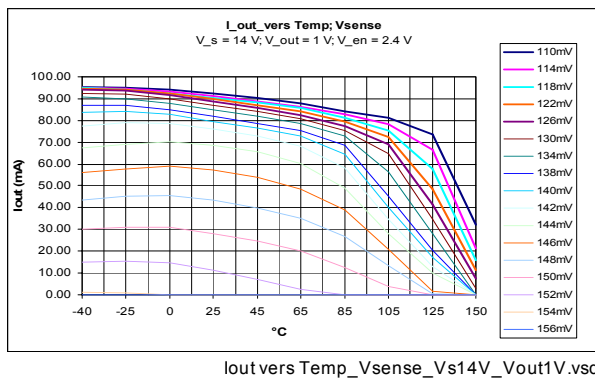

I_{out} vers V_{sense} (Temperature)

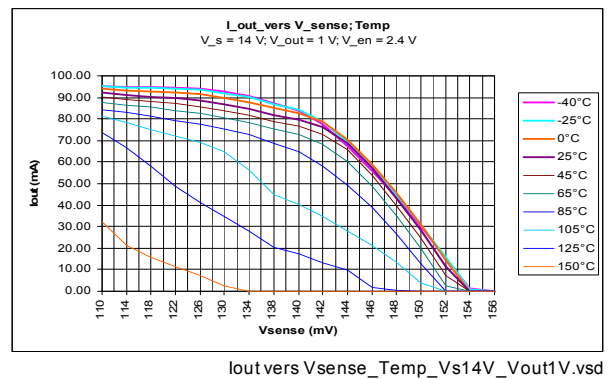

$V_s = 27\text{ V}$, $V_{out} = 1\text{ V}$; $EN = 2.4\text{ V}$

I_{out} vers Temperature (V_{sense})

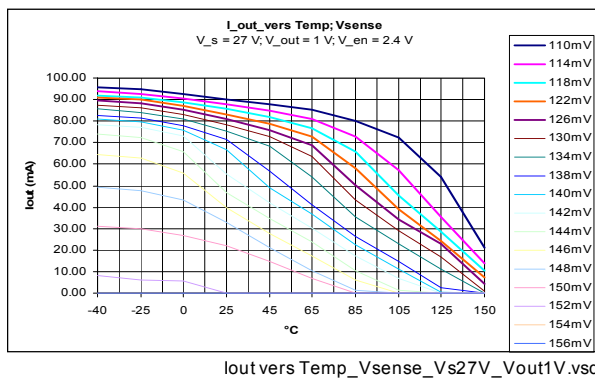

I_{out} vers V_{sense} (Temperature)

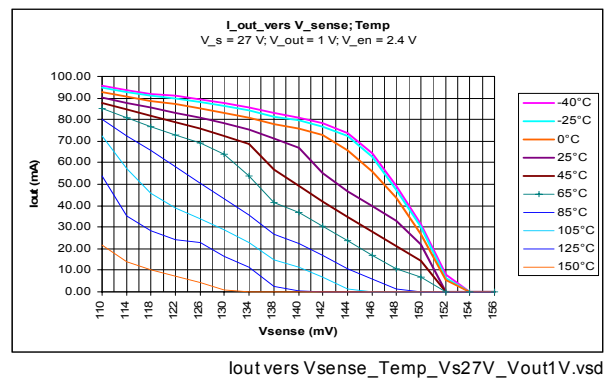

$V_s = 14\text{ V}$, $V_{out} = 6\text{ V}$; $EN = 20\text{ mV}$

I_{out} vers EN (Temperature)

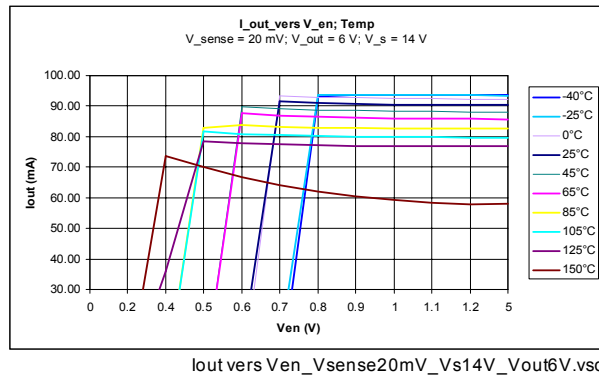

$V_s = 14\text{ V}$, $V_{sense} = 20\text{ mV}$; $EN = 2.4\text{ V}$

I_{out} vers Temperature (V_{out})

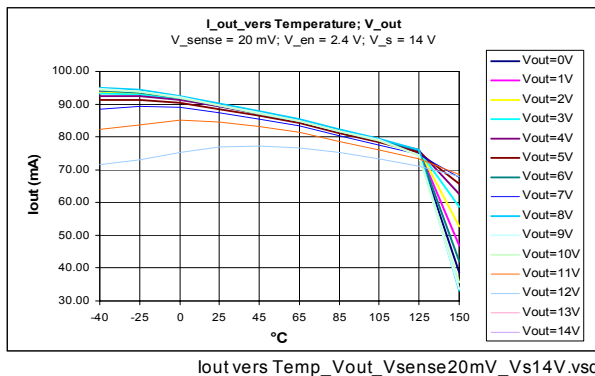

I_{out} vers V_{out} (Temperature)

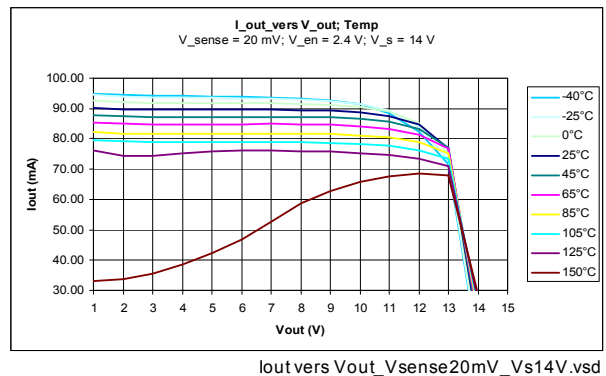

$V_{out} = 1\text{ V}$, $V_{sense} = 20\text{ mV}$; $EN = 2.4\text{ V}$

I_s vers V_s (Temperature)

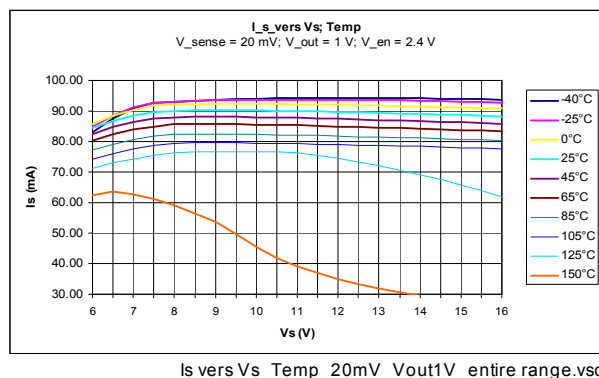

$V_{out} = 6\text{ V}$, $V_{sense} = 20\text{ mV}$; $EN = 2.4\text{ V}$

I_s vers V_S (Temperature)

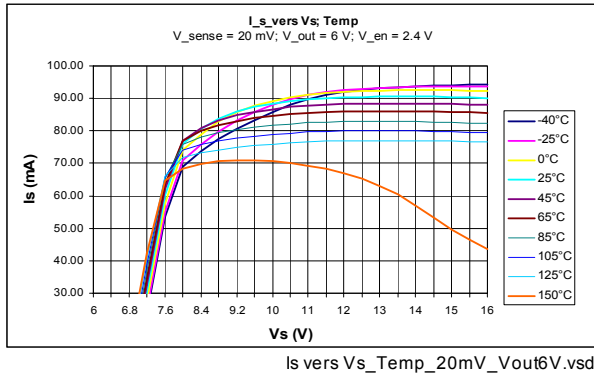

I_s vers V_S (Temperature)

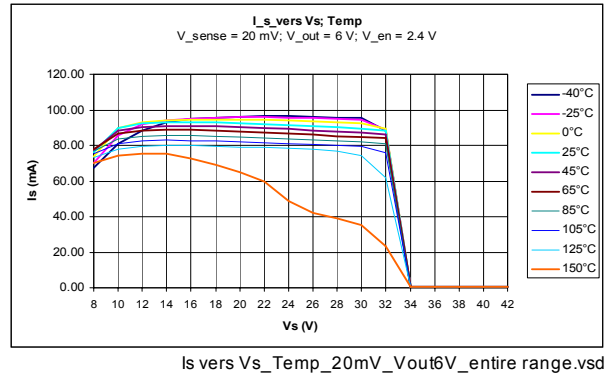

$I_{s\text{ short}} \rightarrow V_{out} = 0\text{ V}$, $V_{sense} = 0\text{ mV}$; $EN = 2.4\text{ V}$

I_s vers V_S (Temperature)

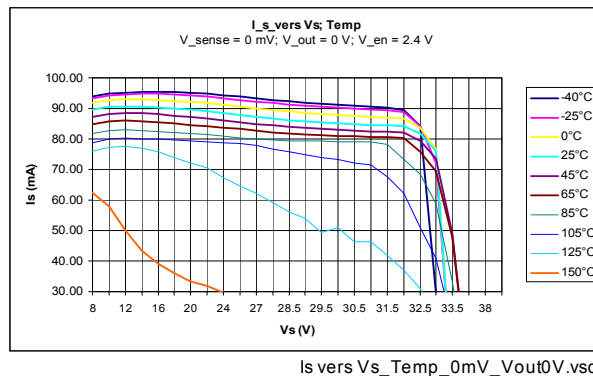

$I_{s\text{ standby}} \rightarrow V_{out} = 0\text{ V}$, $V_{sense} = 0\text{ mV}$; $EN = 0\text{ V}$

I_s vers V_S (Temperature)

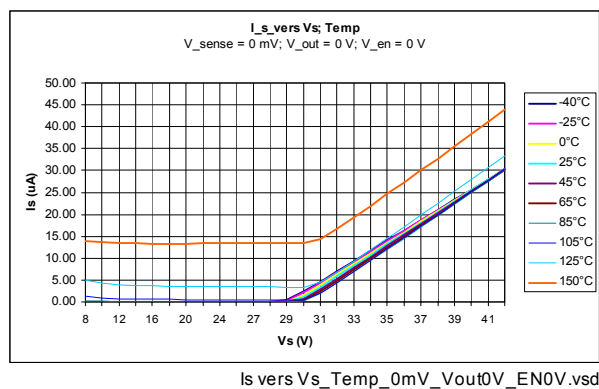

$V_{out} = 6\text{ V}$, $I_{out} = 15\text{ mA}$; $EN = 2.4\text{ V}$

V_{sense} vers Temperature (V_s)

V_{sense} vers V_s (Temperature)

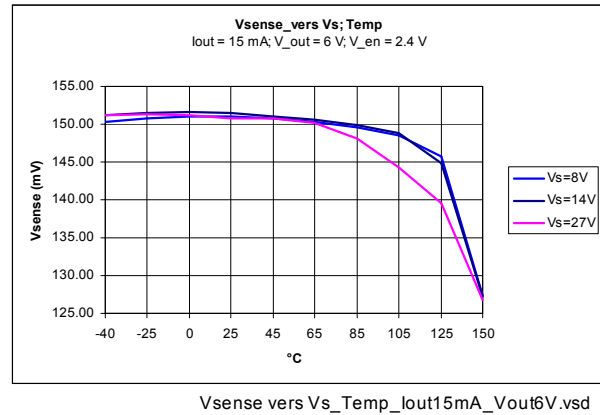
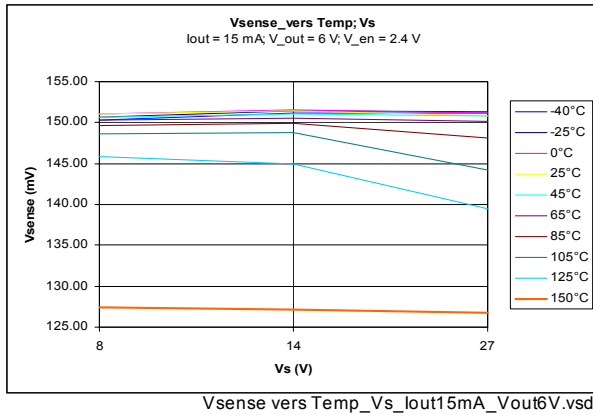

4.2 AC- Parameter

Response Time

T_{on} & T_{off} ; $V_s = 12\text{ V}$; $f_{pulse} = 1\text{ KHz}$; $t_{duty} = 50\%$

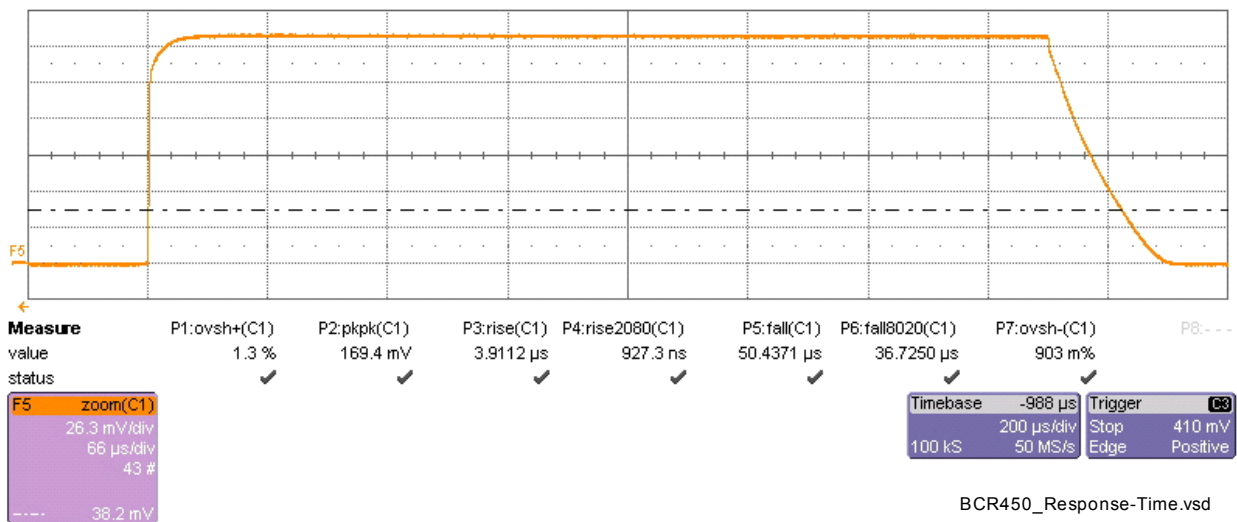

Unity Gain Bandwidth G_{BW} ; $V_s = 8 V^{(1)}$

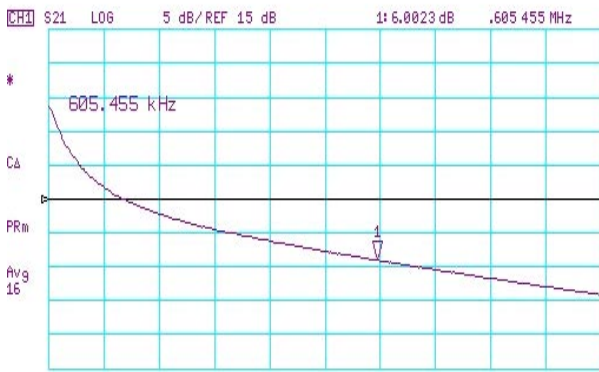

BCR450_GBW_8V.vsd

Unity Gain Bandwidth G_{BW} ; $V_s = 27 V$

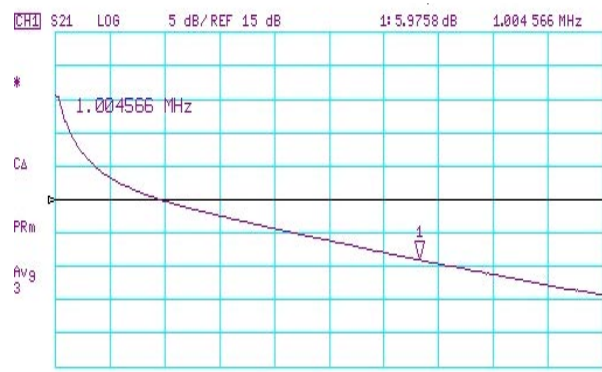

Bcr450_gbw_27v.vsd

1) Marker read out at 6 dB due to the highohmic load of the operational amplifier, NWA is calibrated with 50 Ohm

Phase Margin PM_G ; $V_s = 8 V$

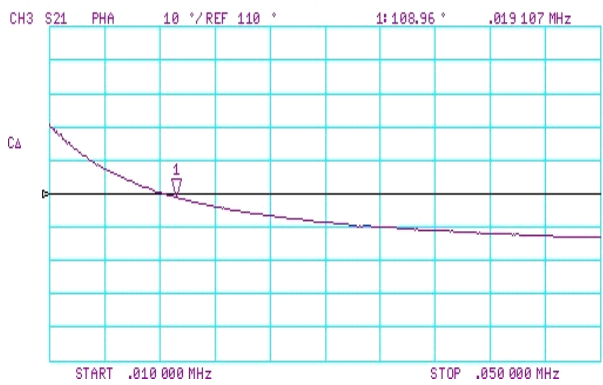

Bcr450_PMg_8v.vsd

Phase Margin PM_G ; $V_s = 27 V$

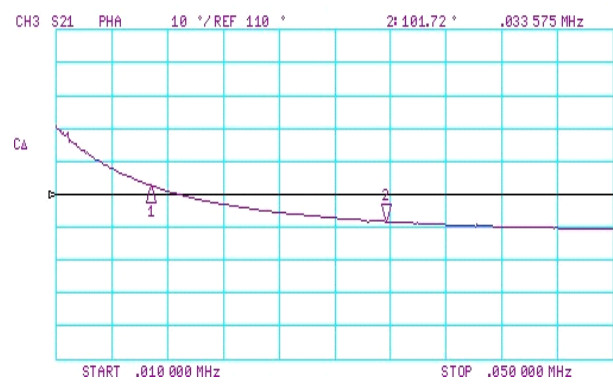

Bcr450_PMg_27v.vsd

5 Evaluation Board

The evaluation board is designed to test the BCR450 as a stand alone device for lower LED current applications and also with additional external “booster” transistors for high current, high brightness LEDs. Up to three external transistors BCX68 or BC817SU each could be used on the PCB to minimize thermal problems.

3 LEDs in series for high current mode or 3 LEDs for low current applications can be chosen by setting resistors (see Figure 4). The particular sense voltage can be derived by jumpers which are provided in the layout for each test case. Additional test circuit is included to measure AC characteristics, and the ENABLE input is designed to connect a PWM signal. The PCB is manufactured in double sided FR4 with substrate thickness of 1.0 mm.

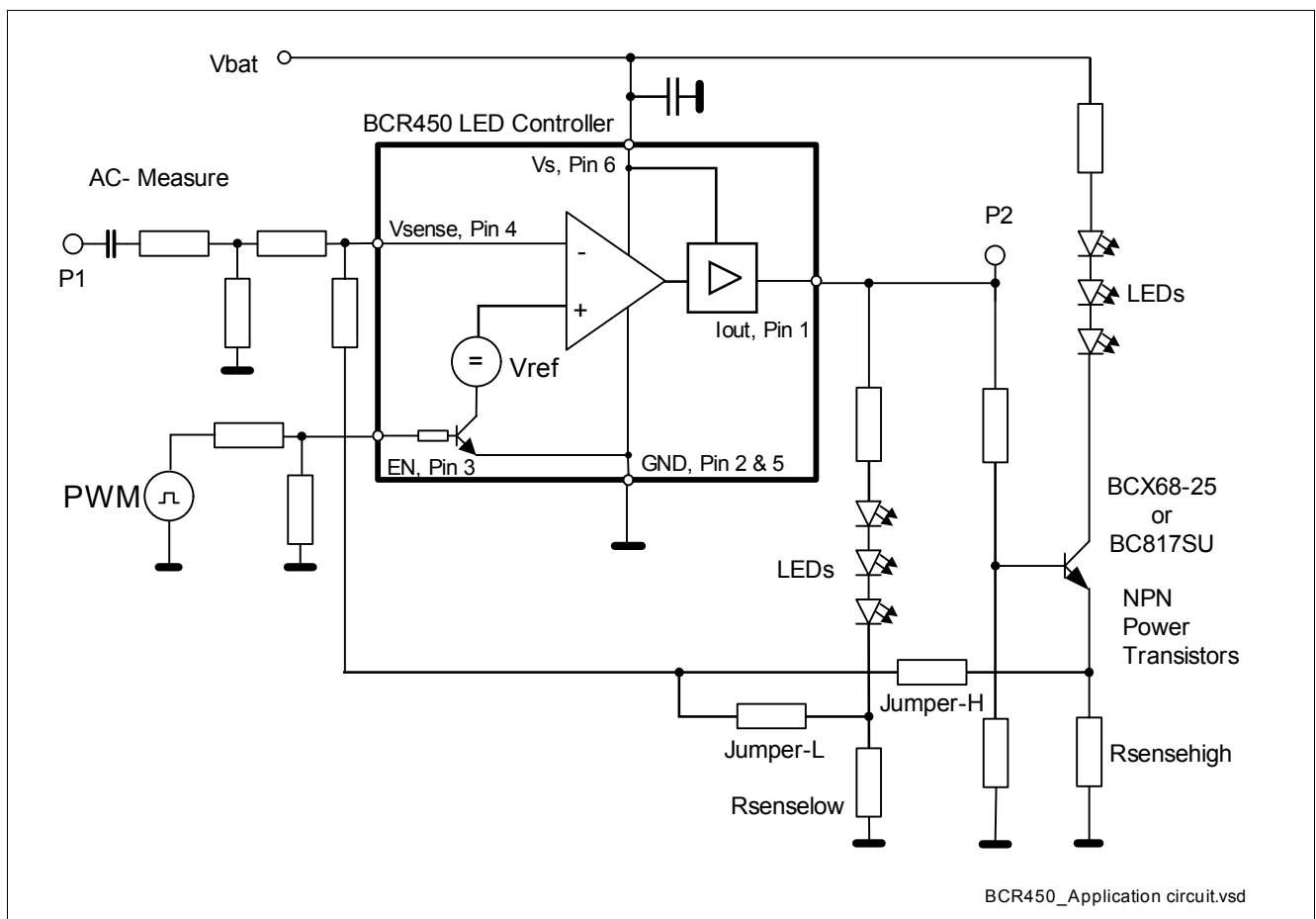

Figure 5 Evaluation board schematic

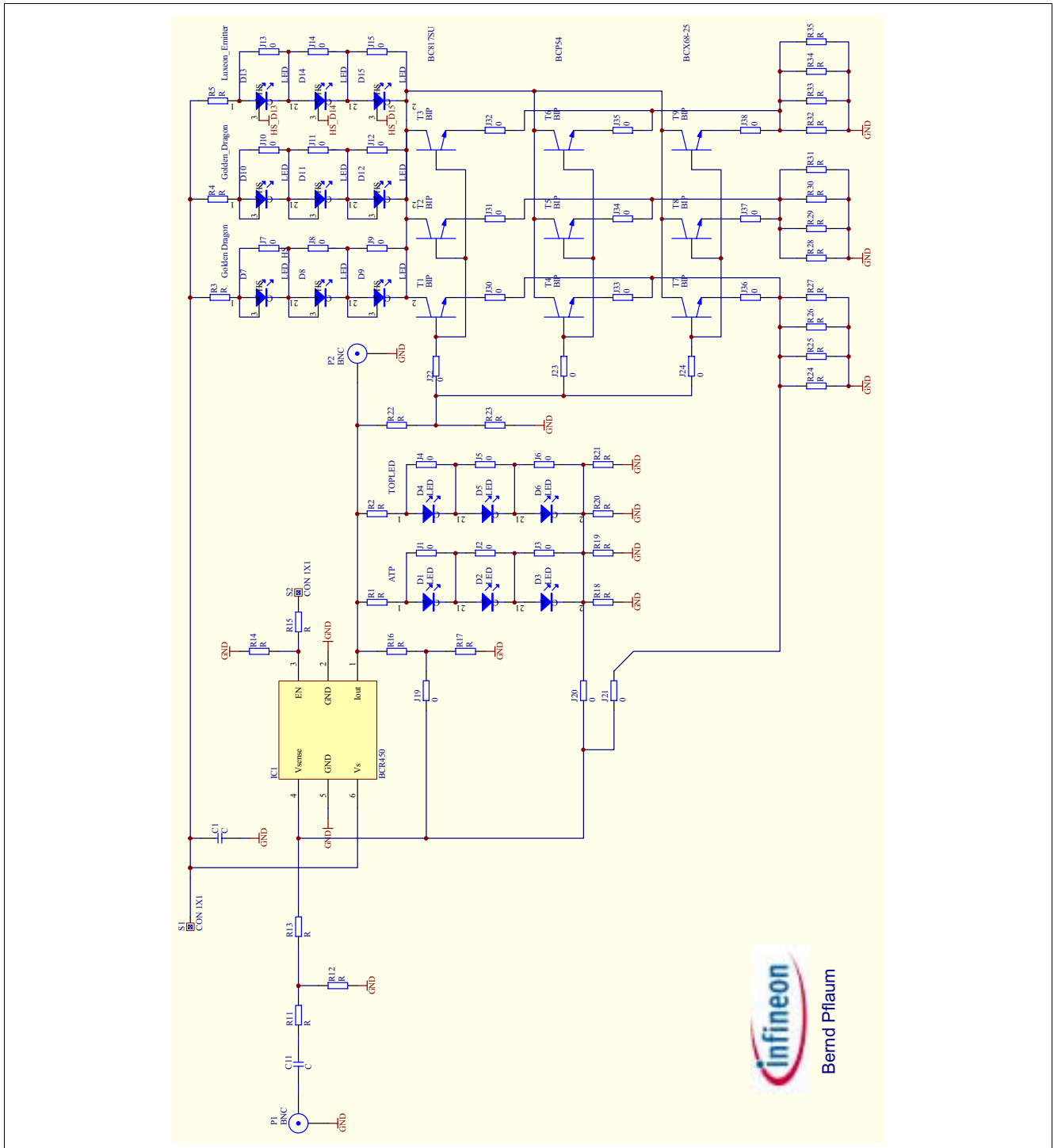

Figure 6 Detailed evaluation board schematic

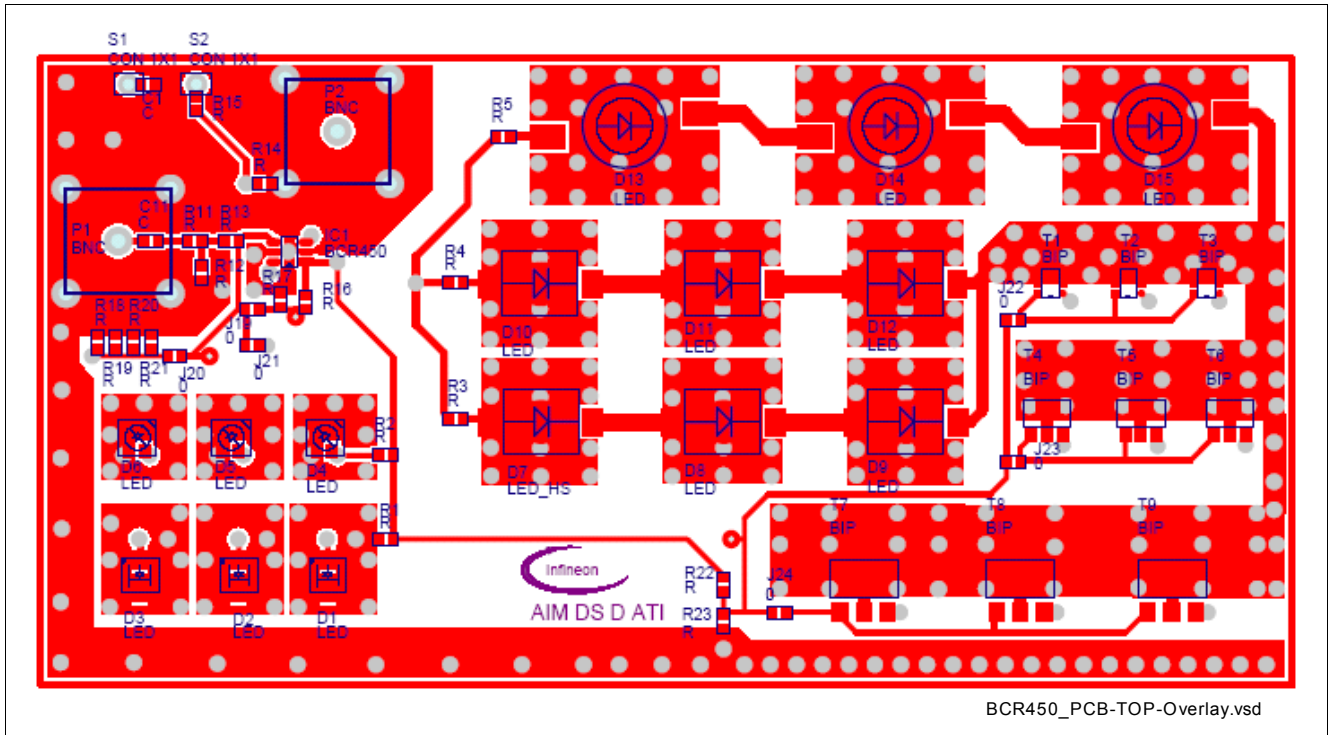

Figure 7 Top view on evaluation board (dimension 60 mm x 120 mm)

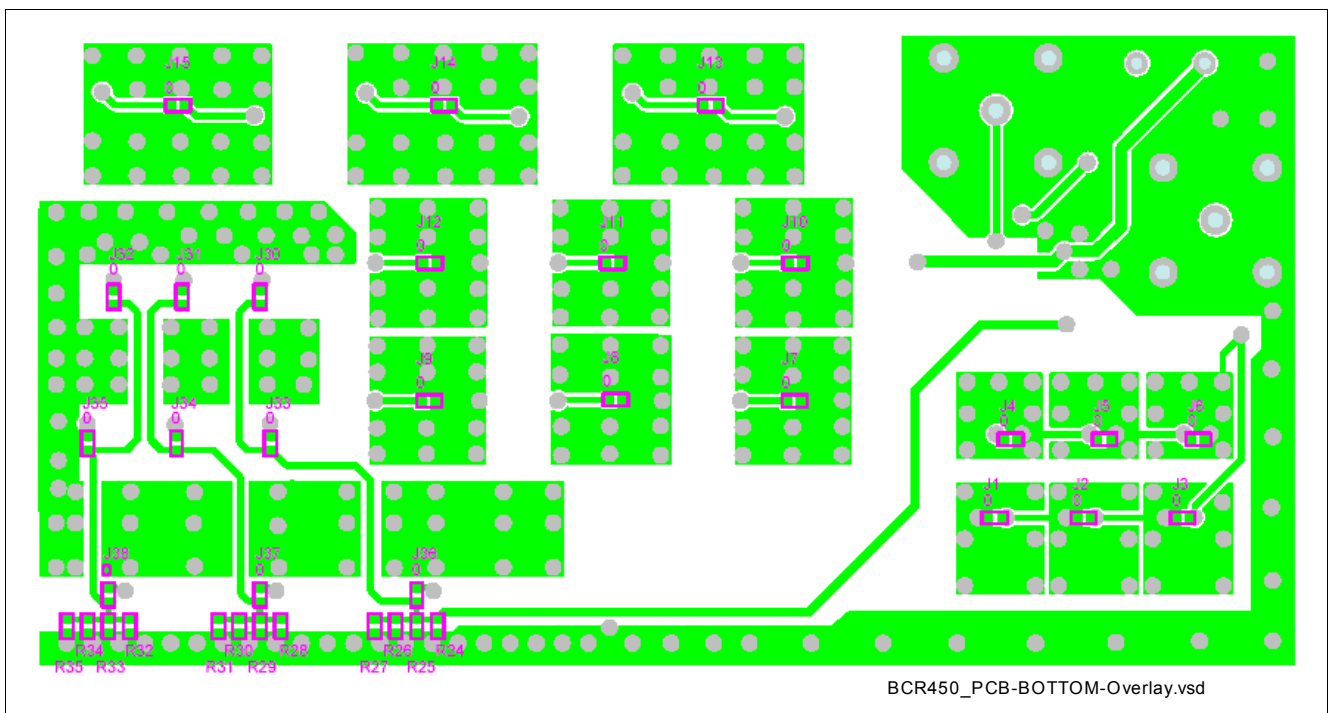

Figure 8 Bottom view on evaluation board (dimension 60 mm x 120 mm)

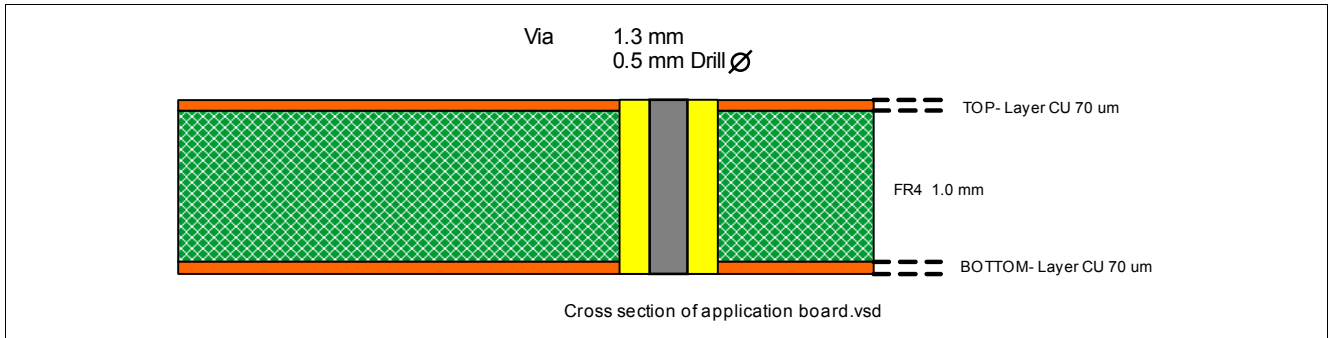

Figure 9 Cross section of evaluation board

6 Package Information

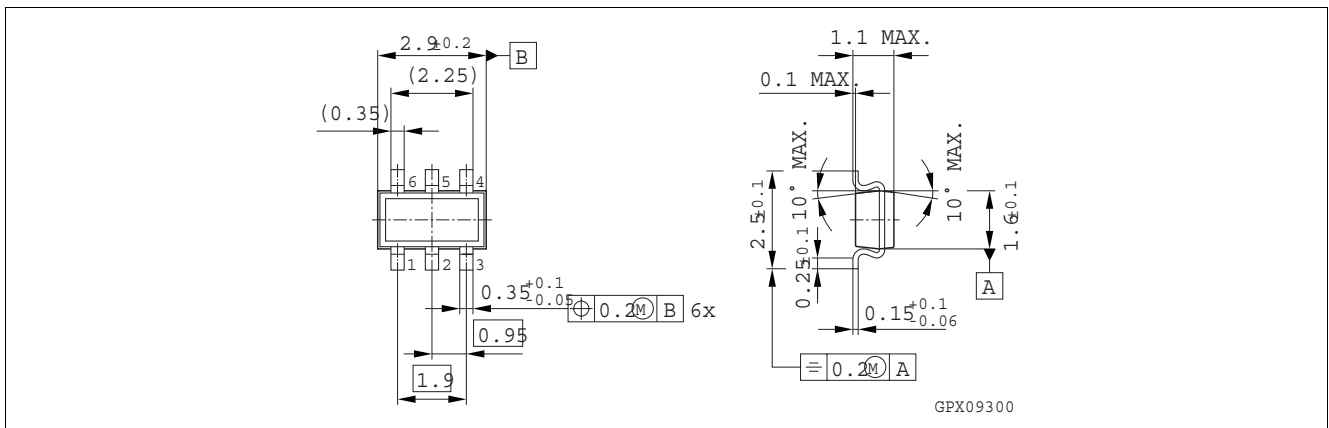

Figure 10 Package outline; TSOP6 / SC74

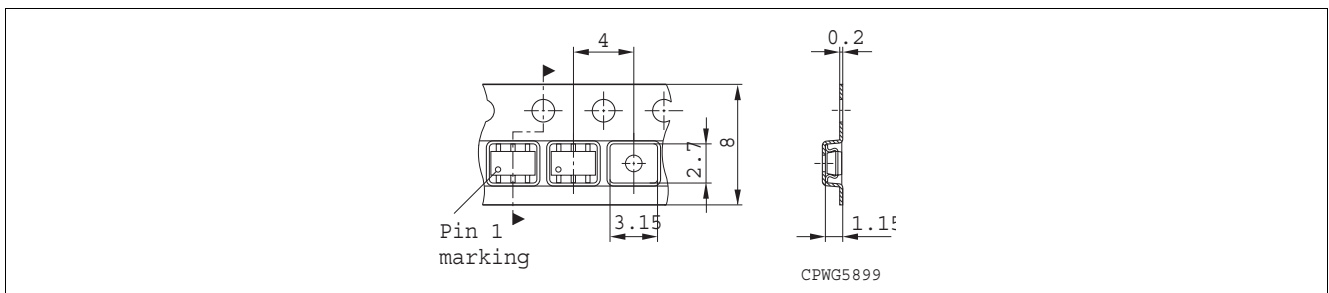

Figure 11 Tape loading